

Basic Configuration – Overview

Note. Refer to the relevant page of the Programming Guide for further information.

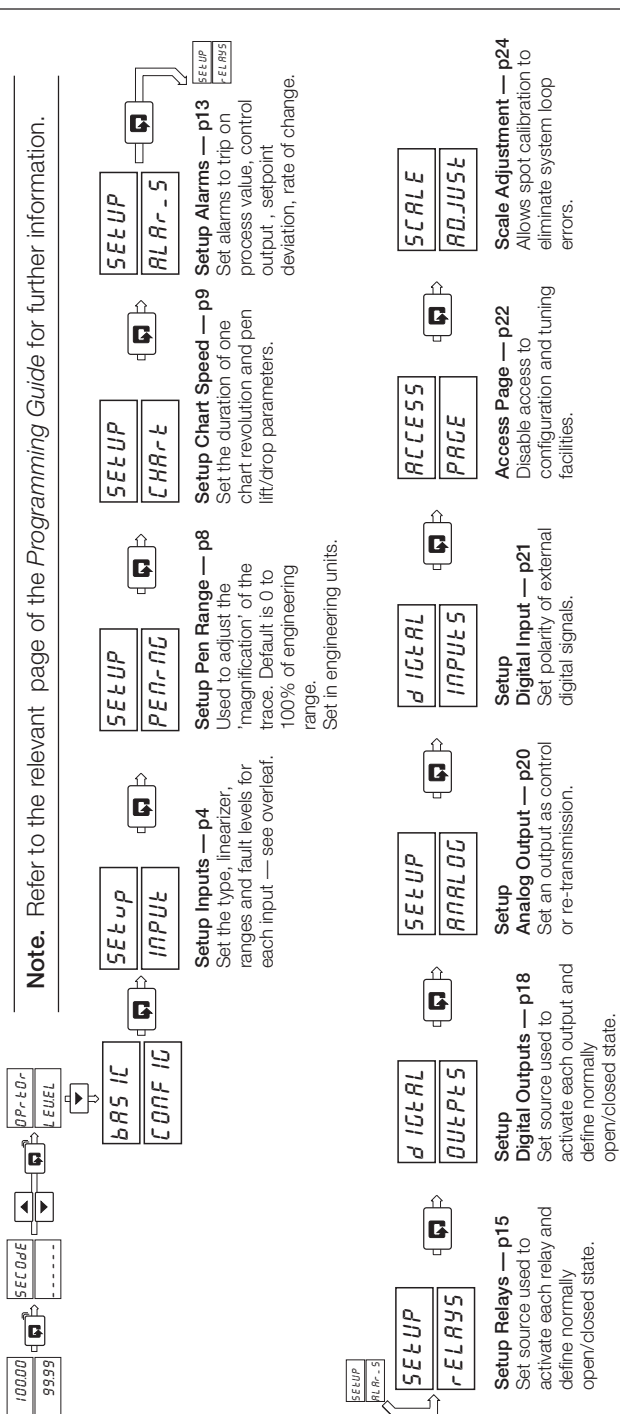

Displays and Controls

Recorder Faceplate

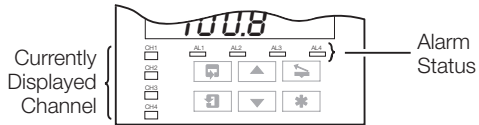

Sideways Scroll



Advance to next page

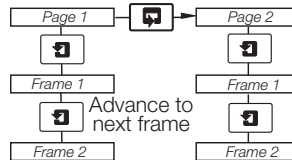

Down Scroll



Advance to next frame



Raise and Lower

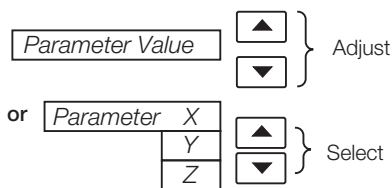

Function Key



'Alarm acknowledge' or 'Home' — See Programming Guide, 'Advanced Configuration'

Pen Lift



Raises and lowers the chart pen.

Note. All programming is carried out using the faceplate keys and displays.

The Company's policy is one of continuous product improvement and the right is reserved to modify the information contained herein without notice.

© ABB 2010

08.2010



ABB Limited
 Howard Road, St. Neots
 Cambridgeshire, PE19 8EU
 UK
 Tel: +44 (0)1480 475321
 Fax: +44 (0)1480 217948

ABB Inc.
 125 E. County Line Road
 Warminster, PA 18974
 USA
 Tel: +1 215 674 6000
 Fax: +1 215 674 7183

Quick Reference Guide IM/C1900-QR Rev. D

C1900 Series Circular Chart Recorders

Operating Guide

Alarms	10	Function keys	27
Acknowledge	10	Inputs (PV, RSP, P-FB)	4
LED status	10	Logic equations	28
Chart	4	Logic inputs	28
Displays & controls	5, 6	Passwords	2, 22
Fault-finding	13	Pen	8
Input error messages	3	Process variable – see Inputs	
Power-up error codes	2	Relays	15
Pen – fitting	4	Retransmission outputs – see Analog outputs	
Process variable	9	Scale adjust (span/offset)	23
Security Access		Spot calibration – see Scale adjust	
Configuration level	12		
Password	12		
Tune level – access	12		
Self-test	2		
Time/date	9		
Totalizer	11		



Programming Guide



Installation Guide

Accessories	2
Electrical installation	6
Siting	3
Mounting/dimensions	4
Power supplies	12
Inputs/outputs	7



Power and productivity
for a better world™



Setting Analog Input Links

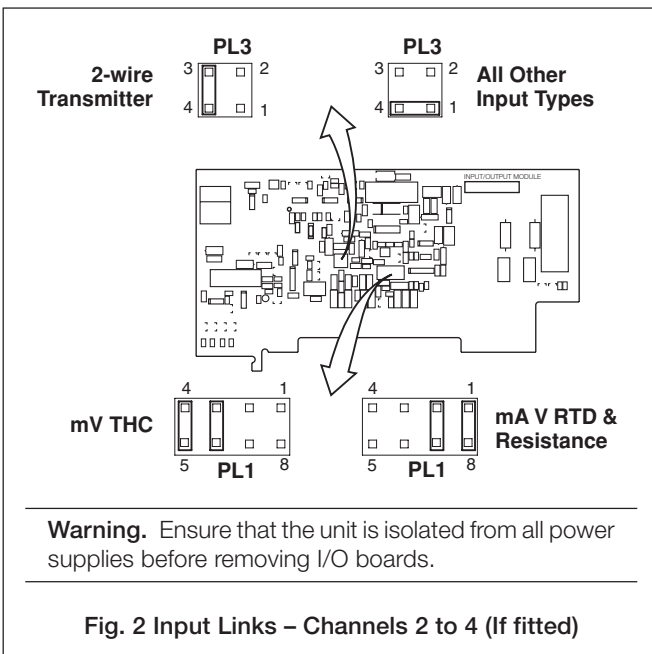
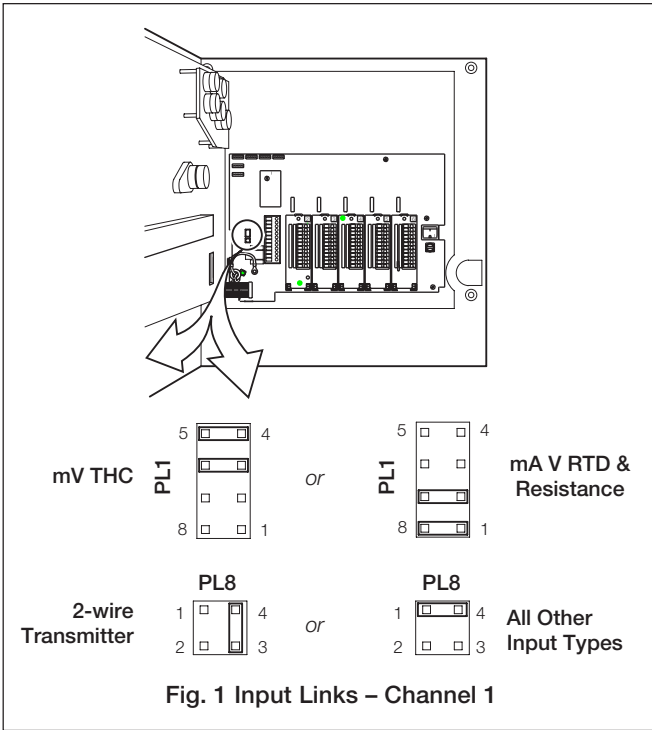

Configuring Analog Inputs

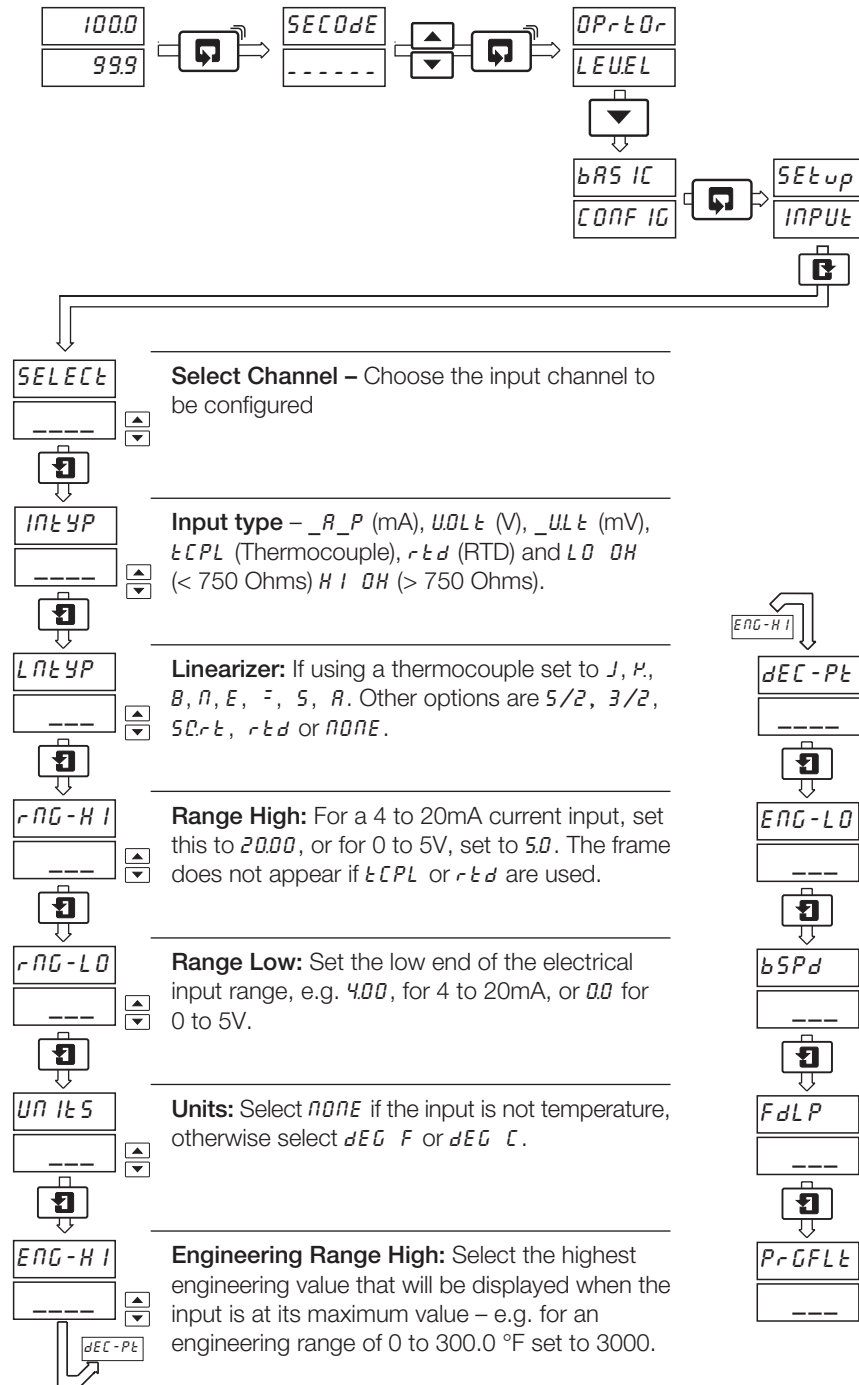

Information. The alphabet used to display page and parameter titles is as follows:

A – <i>A</i>	M – <i>_</i>
B – <i>b</i>	N – <i>n</i> or <i>n</i>
C – <i>C</i> or <i>c</i>	O – <i>O</i> or <i>o</i>
D – <i>d</i>	P – <i>P</i>
E – <i>E</i>	Q – <i>Q</i>
F – <i>F</i>	R – <i>r</i>
G – <i>G</i>	S – <i>S</i>
H – <i>H</i> or <i>h</i>	T – <i>t</i>
I – <i>i</i>	U – <i>U</i>
J – <i>J</i>	V – <i>V</i>
K – <i>K</i>	Y – <i>Y</i>
L – <i>L</i>	

